

ZTS-100
(Z-Thermostat)

Table of Contents

Introduction	3
<i>Features list</i>	<i>3</i>
Glossary	5
Physical Installation and Wiring	6
<i>Installation Location</i>	<i>6</i>
<i>Wiring</i>	<i>6</i>
<i>Jumper settings for ELECTH-HPUMP and HE-HG</i>	<i>8</i>
<i>Mounting</i>	<i>9</i>
ZTS-100 Z-Thermostat Operations	10
<i>Configurations</i>	<i>10</i>
<i>Description of Function Keys</i>	<i>10</i>
Normal Operation Mode	11
<i>Change Operation mode</i>	<i>11</i>
<i>Select Fan mode</i>	<i>12</i>
<i>Select Program mode</i>	<i>12</i>
<i>Override/Permanent Override</i>	<i>13</i>
Setting Mode	14
Setting schedule	16
Z-Wave Add (Inclusion) / Delete (Exclusion) Mode	18
<i>Delete ZTS-100 from Gateway / Controller Z-Wave network</i>	<i>19</i>
<i>Add ZTS-100 to Gateway / Controller Z-Wave network</i>	<i>19</i>
Filter counter	20
Reset ZTS-100 to factory default settings	21
Battery Low indication	22
Defrost indication	22
Out of temperature range indication	22
Advance Recovery indication	23
Short cycle start up protection	24
FREQUENTLY ASKED QUESTIONS	24
TECHNICAL SPECIFICATIONS	26
CHECKING THE ACCESSORIES	27
FCC NOTICE	27
WARNINGS	27

ZTS-100 Z-Thermostat

Introduction

Welcome to the Z-Wave world of home automation, your ZTS-100 Z-Thermostat (Figure 1) is a comfort control master that allow to control your room temperature with programmable time schedule WAKE, AWAY, HOME and SLEEP event which can maximize energy conservation and comfort while minimizing the effort required to maintain the appropriate temperature in your home whether you are at home or away.

Also, it is allow to control / check your room temperature by the smart phone or PC while you are at office, home anywhere or around the world which can go through the Z-Wave gateway control.

ZTS-100 also supports batteries operation that can provide flexibility if there is out of 24VAC power line.

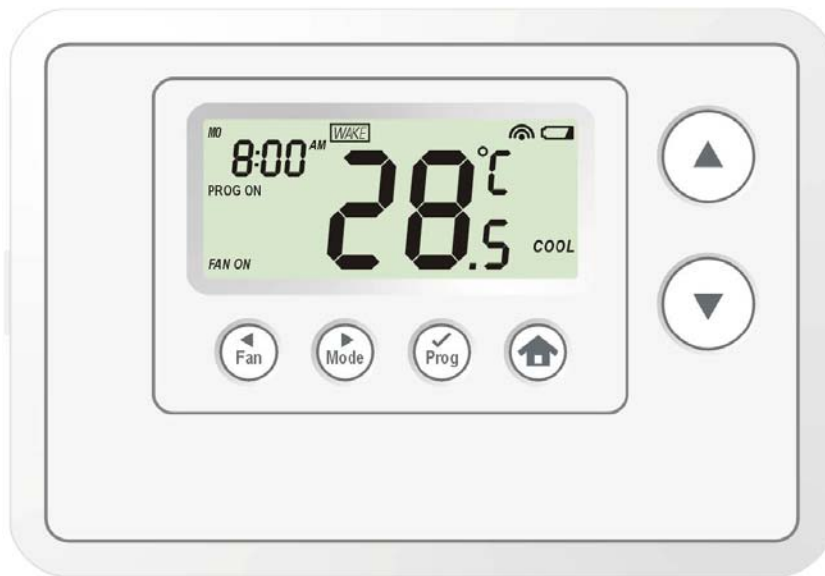

Figure 1. ZTS-100

Features list

HVAC System Type Compatible:

- Standard (gas/electric) or Heat Pump

Multistage System Compatible:

- Standard HVAC Systems: 2 stage heating, 1 stage cooling
- Heat Pump Systems: 1 stage heating, 1 stage cooling

Heat Pump change over valve:

- Selectable change over with cool or with heat

Power:

- Powered by alkaline batteries AA x 4pcs or 24Vac

Program Style:

- 2 program modes for scheduling (Mo-Fr, Sa-Su)
- 4 Separate Time and Temperature Settings for each program
- Heat and Cool set-points for each program
- Temporary Program Override
- Permanent Program Override
- Built-in flash memory stores heat and cool program settings

Temperature Display and Control:

- Temperature display in °F or °C
- Temperature Measurable Range: 32 – 99 °F / 0 – 40 °C
- Temperature Setting Range: 41-99 °F / 5-37 °C
- Adjustable Temperature Control Swing/Differential
 - a) Swing: 1°F, 2°F, 3°F or 4°F (0.5°C, 1.0°C, 1.5°C or 2°C)
 - b) Differential: 1°F, 2°F, 3°F or 4°F (0.5°C, 1.0°C, 1.5°C or 2°C)
- Advance Recovery Mode (ARM)
- Defrost Function
- Short cycle start up protection

Clock:

- Time display format: 12/24 hour clock selection with day displayed

Filter Counter:

- Counts up to 999 days
- Filter change reminder displayed after 500 hours usage

Others

- Battery Low Indicator
- White LCD Backlight

Glossary

Device or Node	Devices and nodes are all terms to describe an individual Z-Wave device. These are all interchangeable when setting up your Z-Wave network.
Inclusion	Add a Z-Wave device to the network.
Exclusion	Delete a Z-Wave device from the network.
Remove	To take a device out of a group, scene or association group while that device still exists in the same Z-Wave network.
Z-Wave Network	A collection of Z-Wave devices controlled by primary and secondary controllers operating on the same system. A Z-Wave network has its own unique ID code so that controllers not in the network cannot control the system.
Primary Controller	The first controller used to set up your devices and network. Only the Primary Controller can be used to include or delete devices from a network. It is recommended that you mark the primary controller for each network for ease in modifying your network.
Secondary Controller	A controller containing network information about other devices within the network and is used for controlling devices. Secondary controllers are created from the Primary Controller and cannot include or delete devices to the network.
Inclusion Controller	A controller containing network information about other devices within the network and is used for controlling devices. Inclusion controllers are created from the Primary Controller in a SIS enabled Z-Wave network. Inclusion Controller has the ability to add and remove devices from the network.
Scene	A collection of Z-Wave devices configured to turn to a specific level, setting, mode, or perform an operation. Scenes are usually activated by a controller, timed event, or specific conditions.

Physical Installation and Wiring

ⓘ CAUTION

- Read the enclosed instructions carefully before installing your new Z-Thermostat. Pay close attention to all warnings and notes and carefully follow the installation steps in the order they are presented to save time and minimize the risk of damaging the thermostat or the system it controls.
- Turn off ZTS-100 and the electronic devices (e.g. heater, cooler) which will be connected and the electric source before installation and maintenance. It is highly recommended that the installation procedure is processed by trained personnel.

Battery safety!

- Use new batteries of the recommended type and size only.
- Never mix used and new batteries together.
- To avoid chemical leaks, remove batteries from the ZTS-100 if you do not intend to use the unit for an extended period of time.
- Dispose of used batteries properly; do not burn or bury them.

Installation Location:

The Thermostat is restricted to be used in indoor only. It should be mounted on an inner wall about 1.5m above the floor at a position where it is readily affected by changes of the general room temperature with freely circulating air. Avoid mounting above or near hot surfaces or equipment (e.g. TV, heater, refrigerator). Avoid mounting where it will be exposed to direct sunshine, drafts, or in a laundry room or other enclosed space. Do not expose this unit to dripping or splashing.

Wiring:

- Be sure the operation mode is OFF and Fan selection is Fan Auto
- Wire the proper cables at the terminal block according to the circuit diagram
- Afterward, push all cables back into the wall
- Do not use metal conduit or of cable provided with a metal sheath
- Recommends adding fuse or protective device in the line circuit

Terminals	Symbol
Cool changeover (heat pump)	O
Heat changeover (heat pump)	B
2nd Stage heater	W2
1st Stage heater	W1
Fan	G
Compressor	Y
24VAC Return for Cooling call switch power	RC
24VAC Return for Heat call switch power	RH
24VAC Common	C

Important!

The ZTS-100 can be powered by alkaline batteries AA x 4pcs or 24Vac. Connect the “24VAC Common” (typically the Blue wire/terminal) and “24VAC Return” (typically the Red wire/terminal) from the HVAC system to the ZTS-100 HVAC System terminal block “C” and “RH” or “RC” terminals (the RH and RC terminals are default tied together).

Common or Split Transformer Systems:

Most HVAC systems have a common heating and cooling transformer. A wire is connected to tie the RH and RC inputs together for this configuration. If you have a system with separate heating and cooling transformers, you will need to disconnect the RH and RC wire.

When wiring split systems, wire the heating systems “24VAC Return” (red wire) to the ZTS-100 “RH” terminal, and wire the cooling systems “24VAC Return” to the ZTS-100 “RC” terminal. Also wire the cooling systems “24VAC Common” to the ZTS-100 “C” terminals.

Note: Do not split RC/RH for Heat Pump systems!

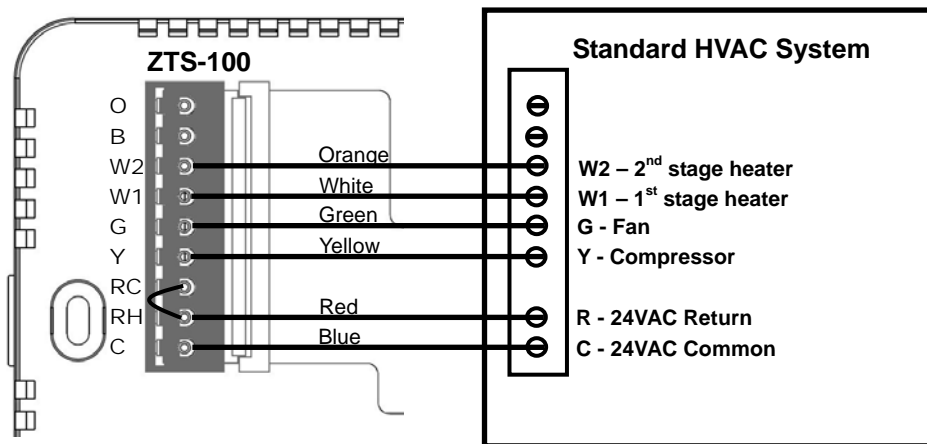

Figure 2. Non-heat pump (Standard Gas or Electric) HVAC system wiring

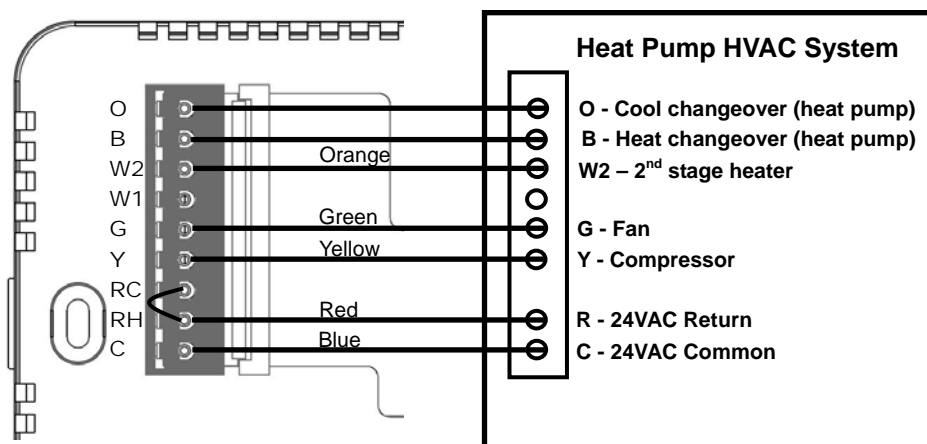

Figure 3. Heat pump system wiring

Jumper settings for ELECTH-HPUMP and HE-HG:

Jumper	Function Description
<input checked="" type="radio"/> ELECTH <input type="radio"/> HPUMP	Set to ELECTH for non heat pump system
<input type="radio"/> ELECTH <input checked="" type="radio"/> HPUMP	Set to HPUMP for heat pump system
HG <input checked="" type="radio"/> HE <input type="radio"/>	Set to HG for Gas heat-fan controlled unit
HG <input type="radio"/> HE <input checked="" type="radio"/>	Set to HE for Electrical heat-fan controlled unit

Mounting:

1. Open the ZTS-100 by pushing the hook (Figure 5)
2. Install AAx4pcs batteries if using battery power (Alkaline batteries are recommended)
3. Check the polarity of the batteries and the "+/-" marks inside the battery compartment
4. Connect 24Vac common at C terminal if using 24Vac power
5. Place the cables at the hole near the terminal block
6. Insert 2 pieces of wall anchors into the holes of the wall
7. Fasten the thermostat with 2 pieces of long screws through the 2 mounting holes (Figure 6)
8. Install the top housing by hooking the bottom (Figure 6)

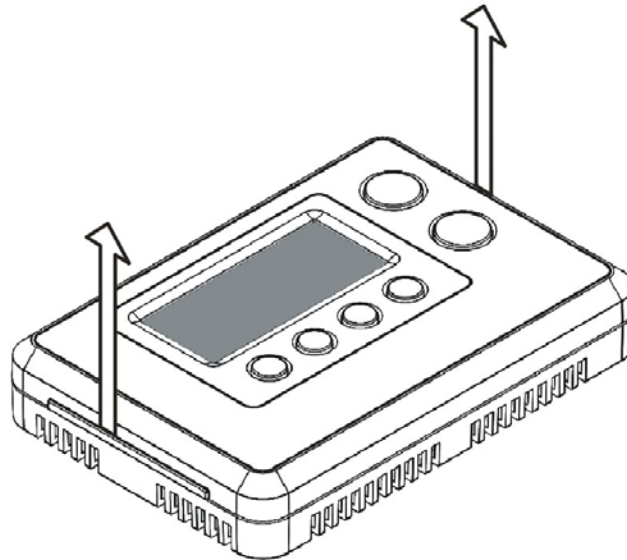

Figure 5. Open ZTS-100

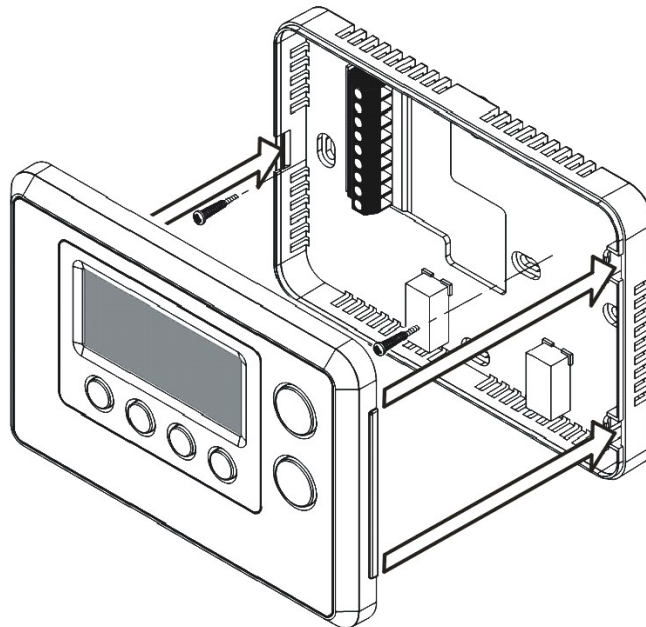

Figure 6. Install the top housing

ZTS-100 Z-Thermostat Operations

The following section will guide you through the set up processes for your ZTS-100.

Please note that all Z-Wave thermostat controllers made from various vendors are compatible with your ZTS-100 as long as they carry the Z-Wave logo:



(Please carefully read through the following then store the manual for future reference.)

Configurations

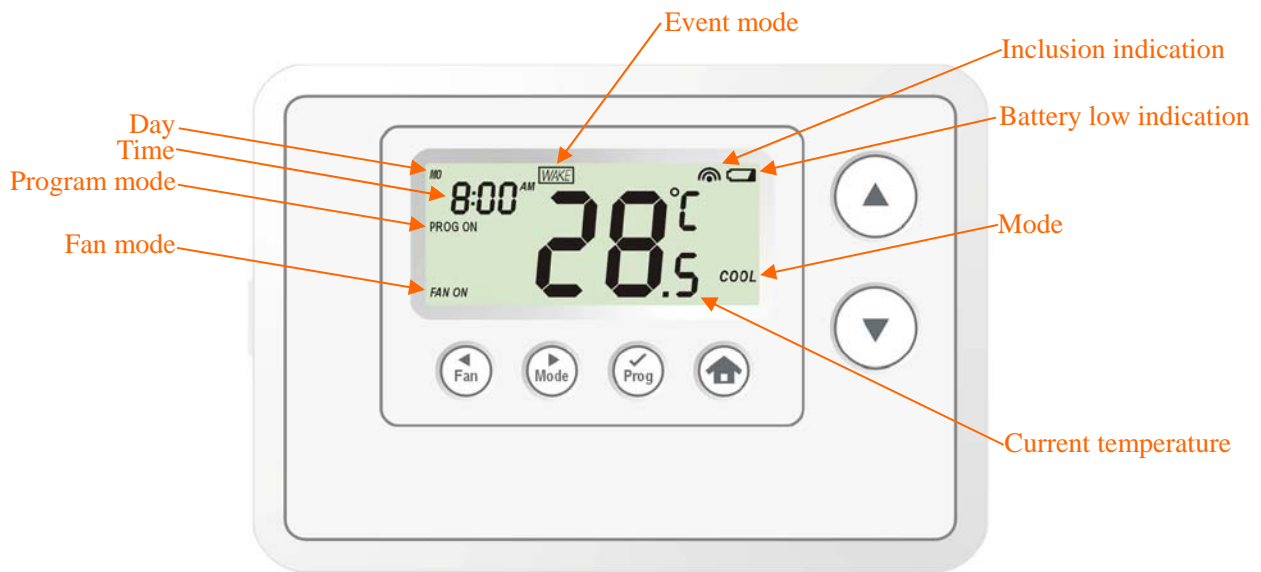

Figure 7. ZTS-100

Description of Function Keys

Symbol	Key Description
	Increase value / Toggle selection
	Decrease value / Toggle selection
	Select fan mode; also the Backward function key in some menus
	Change operation mode; also the Forward function key in some menus
	Select program mode: PROG ON, OVERRIDE and PERMANENT OVERRIDE; also the Confirm function key in some menus
	Back to Home

Normal Operation Mode

Change Operation mode

Note 1: In Heat mode => it displays "HEAT" if ELECTH is selected.

=> it displays "HEAT PUMP" if HPUMP is selected.

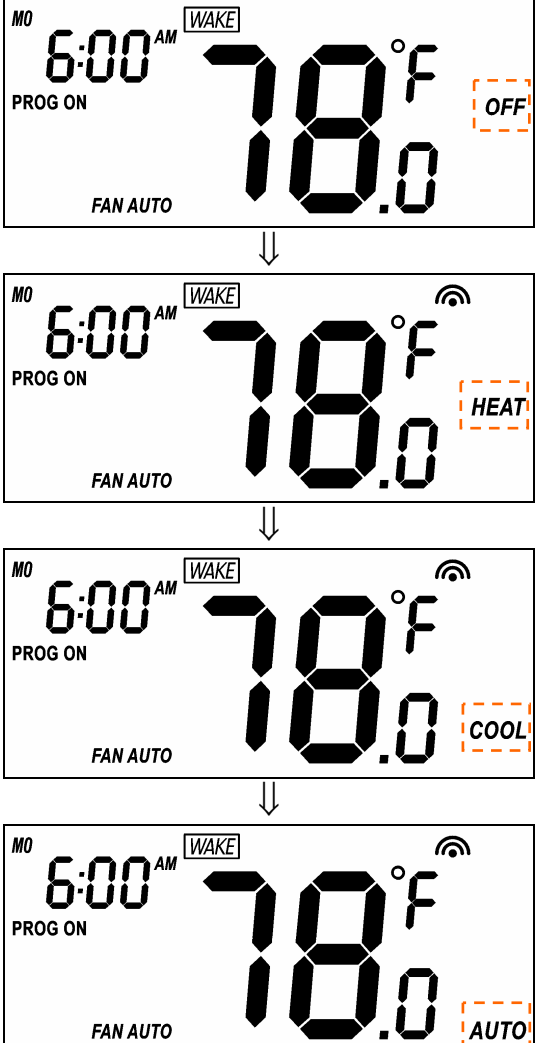
Step	Procedure / Description	LCD indication
1	Press "Mode" key once to change the operation mode: OFF -> HEAT (PUMP) -> COOL -> AUTO -> OFF	 <p>The LCD indication column shows a sequence of four displays, each with a downward arrow below it, representing the mode change process. Each display shows the time '6:00 AM', 'MO', 'WAKE', 'PROG ON', 'FAN AUTO', and a temperature of '78.0 °F'. The mode being selected is indicated by a dashed box on the right side of the display: 'OFF', 'HEAT', 'COOL', and 'AUTO'.</p>

Select Fan mode



Step	Procedure / Description	LCD indication
1	<p>Press “Fan” key once to change the Fan mode: FAN AUTO -> FAN ON</p> <p>FAN AUTO: Electric heat (HE): Fan runs only when Heating/Cooling is running.</p> <p>Gas heat (HG): Fan runs only when Cooling is running.</p>	
2	<p>Press “Fan” key once to change the Fan mode:</p> <p>FAN ON: Fan stays on all the time.</p>	

Select Program mode:



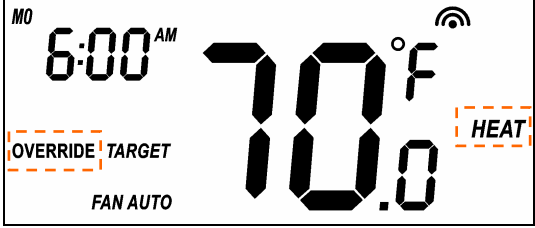

Step	Procedure / Description	LCD indication
1	<p>Press “Prog” key once to select PROG mode: PROG ON -> OVERRIDE ->PERMANENT OVERRIDE</p> <p>PROG ON: Run the schedule.</p>	
2	<p>Press “Prog” key once to select PROG mode:</p> <p>OVERRIDE: Temporary override the current schedule and will go back to “PROG ON” when next time schedule reach.</p>	
3	<p>Press “Prog” key once to select PROG mode:</p> <p>PERMANENT OVERRIDE: Permanent override the schedule until user change back to “PROG ON”.</p>	

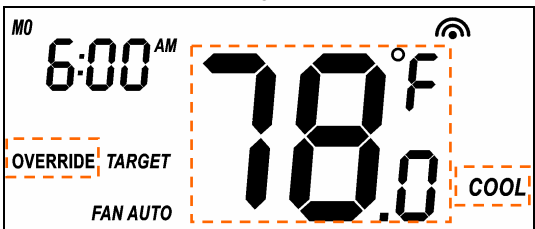
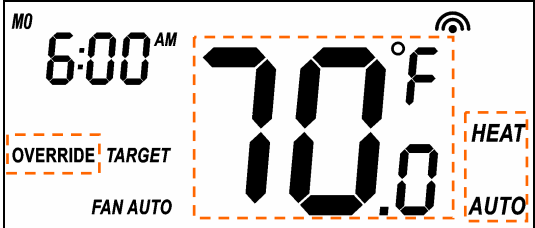
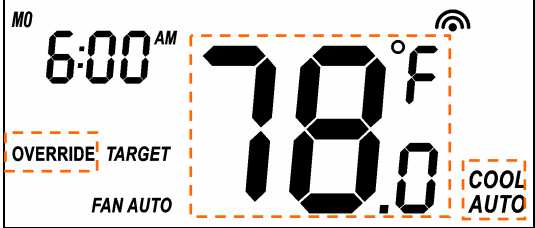
Override/Permanent Override

Note 1: Override/Permanent Override only available in HEAT, COOL or AUTO mode.

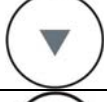
Step	Procedure / Description	LCD indication
1	Press “Prog” key once to select PROG mode: OVERRIDE or PERMANENT OVERRIDE at Home page.	
2	Press Up/Down key to adjust set point temperature in HEAT or COOL mode. Press “Prog” key once to confirm the setting.	 <p style="text-align: center;">or</p> 
3	In AUTO mode, user needs to set heat and cool set points temperature. Press Up/Down key to adjust auto heat set point temperature in AUTO HEAT mode. Press “Prog” key once to confirm the setting.	
4	Press Up/Down key to adjust auto cool set point temperature in AUTO COOL mode. Press “Prog” key once to confirm the setting and back to Home page.	

Setting Mode (set Day, Clock, 12/24 hour, F/C, Swing and Diff.)

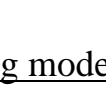
Symbol	Setting Mode Key Description
	Increase value / Toggle selection
	Decrease value / Toggle selection
	Backward to previous setting
	Forward to next setting
	Confirm and go to next setting
	Confirm and back to Home

Setting mode:

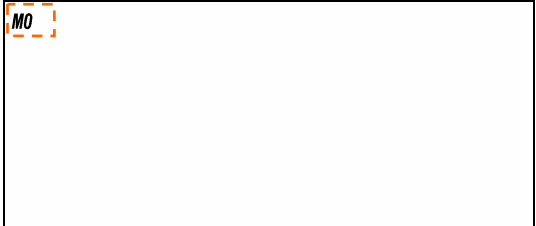
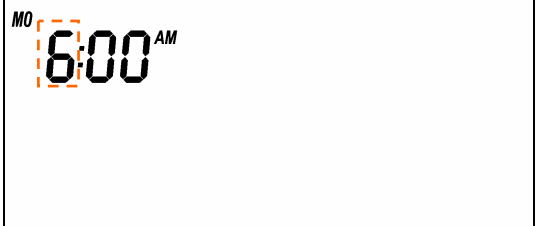
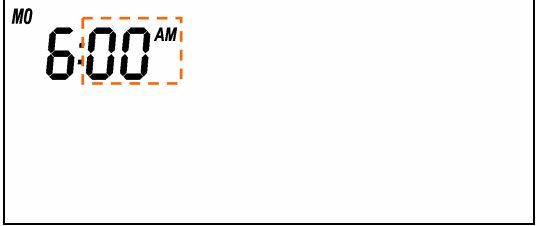
Step	Procedure / Description	LCD indication
1	Press and hold "Mode" key for 2 seconds to entry the setting mode. Day will keep flashing, press Up/Down key to set day from MO-SU.	
2	Press "Prog" key once to confirm the setting and it will go to hour setting. Hour will keep flashing, press Up/Down key to set hour.	
3	Press "Prog" key once to confirm the setting and it will go to minutes setting. Minutes will keep flashing, press Up/Down key to set minutes.	

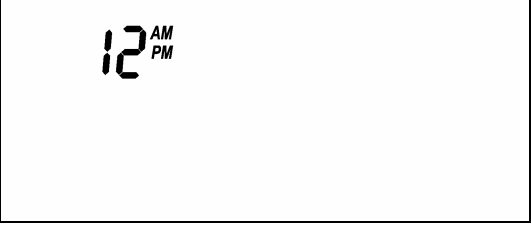
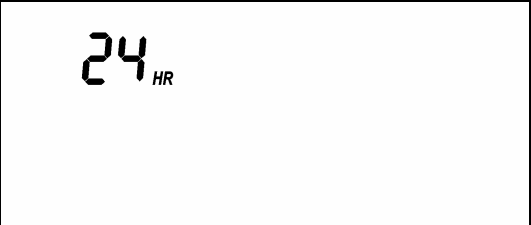
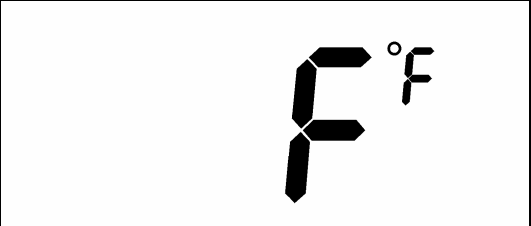
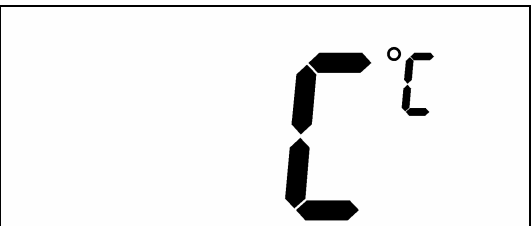
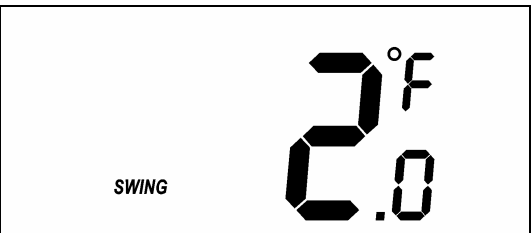
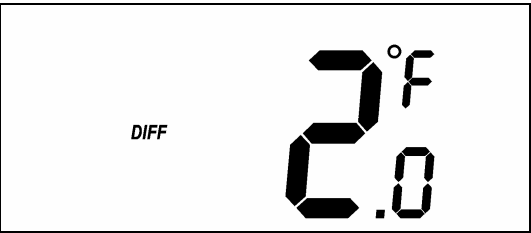
4	<p>Press “Prog” key once to confirm the setting and it will go to 12/24 hour clock selection.</p> <p>Press Up/Down key to toggle the 12/24 hour clock selection.</p>	 <p style="text-align: center;">↓</p> 
5	<p>Press “Prog” key once to confirm the setting and it will go to temperature F -> C selection.</p> <p>Press Up/Down key to toggle the temperature F -> C selection.</p>	 <p style="text-align: center;">↓</p> 
6	<p>Press “Prog” key once to confirm the setting and it will go to swing setting.</p> <p>Press Up/Down key to set the swing setting. (Range is from 0.5°C to 2°C or 1°F to 4°F)</p>	
7	<p>Press “Prog” key once to confirm the setting and it will go to differential set point setting.</p> <p>Press Up/Down key to set the differential set point setting. (Range is from 0.5°C to 2°C or 1°F to 4°F)</p>	

8	Press “Prog” key once to confirm the setting and it will go to the Home page.	
---	---	--

Setting schedule

Default schedule:



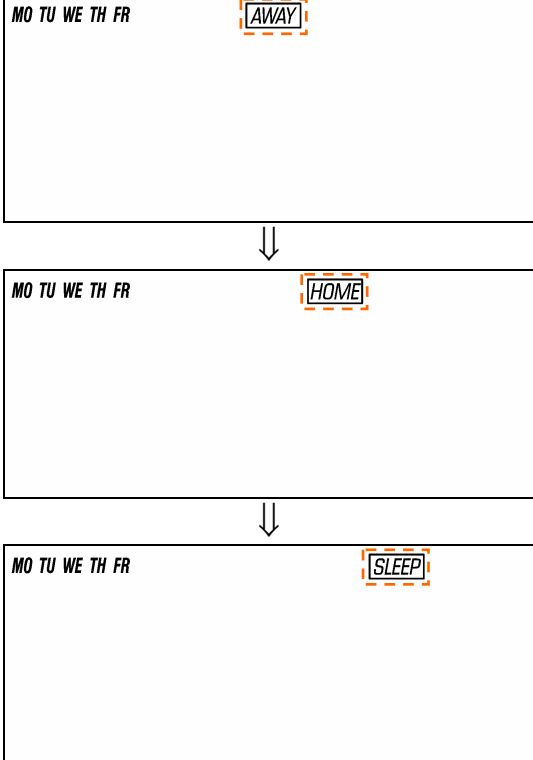
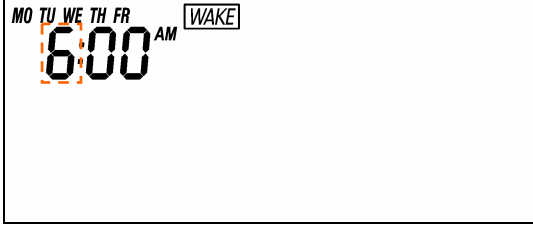
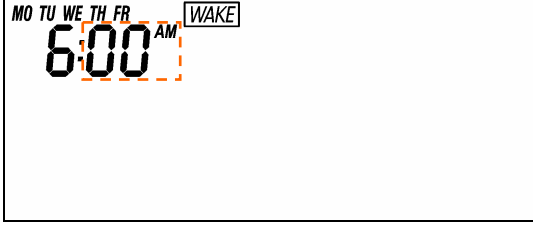
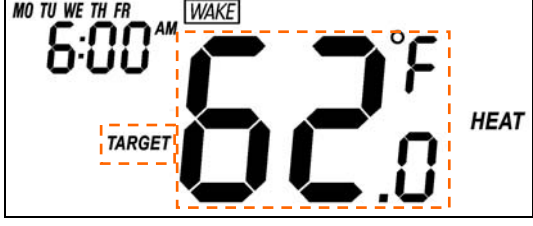

	Event	Time	Heat	Cool
MO - FR	WAKE	6:00 AM	70 °F (21°C)	78 °F (26°C)
	AWAY	8:00 AM	62 °F (17°C)	85 °F (29°C)
	HOME	6:00 PM	70 °F (21°C)	78 °F (26°C)
	SLEEP	10:00 PM	62 °F (17°C)	82 °F (28°C)
SA - SU	WAKE	6:00 AM	70 °F (21°C)	78 °F (26°C)
	AWAY	10:00 AM	62 °F (17°C)	85 °F (29°C)
	HOME	6:00 PM	70 °F (21°C)	78 °F (26°C)
	SLEEP	11:00 PM	62 °F (17°C)	82 °F (28°C)

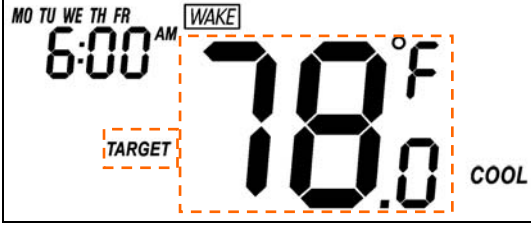
Step	Procedure / Description	LCD indication
1	<p>Press and hold “Prog” key for 2 seconds to entry the setting schedule mode.</p> <p>Press Up/Down key to select MO-FR or SA-SU schedule.</p>	
2	<p>Press “Prog” key once to confirm the setting and it will go to event mode.</p> <p>Press Up/Down key to select the event (WAKE -> AWAY -> HOME -> SLEEP).</p>	

		
3	<p>Press “Prog” key once to confirm the setting and it will go to hour setting.</p> <p>Hour will keep flashing, press Up/Down key to set hour.</p>	
4	<p>Press “Prog” key once to confirm the setting and it will go to minutes setting.</p> <p>Minutes will keep flashing, press Up/Down key to set minutes.</p>	
5	<p>Press “Prog” key once to confirm the setting and it will go to target setting.</p> <p>Target will keep flashing, press Up/Down key to adjust Heat set point for heating.</p>	

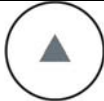
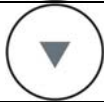
6	<p>Press “Prog” key once to confirm the setting and it will go to target setting.</p> <p>Target will keep flashing, press Up/Down key to adjust Cool set point for cooling.</p>	
7	<p>Press “Prog” key once to confirm the setting and it will go to next event mode.</p> <p>Follow the program UI to complete the whole scheduling or press Home key once to save and exit.</p>	-

Z-Wave Add (Inclusion) / Delete (Exclusion) Mode



Symbol	Inclusion and Exclusion Mode Key Description
	N/A
	N/A
	N/A
	N/A
	Add (Inclusion) / Delete (Exclusion)
	Back to Home

Note 1: This  icon is represent the ZTS-100 has been added into the Z-Wave network.

Please perform the Delete (Exclusion) before add into the new Z-Wave network.

Note 2: User can control the ZTS-100 through gateway or controller after added into the Z-Wave network.

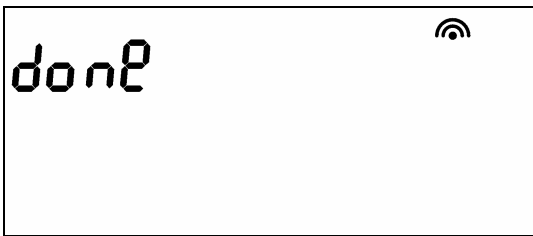
Delete (Exclusion) ZTS-100 from Gateway / Controller Z-Wave network

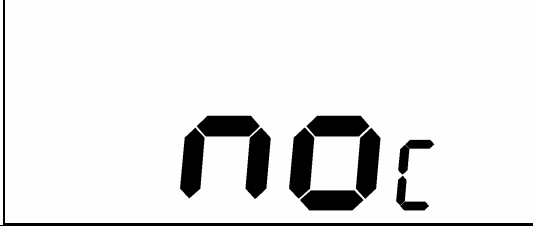
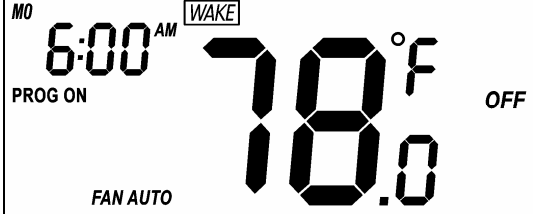
Step	Procedure / Description	LCD indication
1	Gateway / Controller device should enter the Exclusion mode. Press and hold "Home" key for 2 seconds to enter the Add (Inclusion) / Delete (Exclusion) Mode.	
2	Press "Prog" key once, it will search the network.	
3	If the ZTS-100 is removed from the network, it shows no connection. Exclusion is done.	
4	Press "Home" key once to back to the home page.	

Add (Inclusion) ZTS-100 to Gateway / Controller Z-Wave network

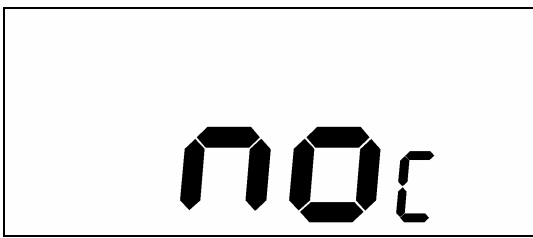
Step	Procedure / Description	LCD indication
1	Gateway / Controller device should enter the inclusion mode. Press and hold "Home" key for 2 seconds to enter the Add (Inclusion) / Delete (Exclusion) Mode.	

2	Press “Prog” key once, it will search the network.	
3	If the ZTS-100 is added into the network, it shows done. Inclusion is done.	
4	Press “Home” key once to back to the home page.	

Filter counter

Step	Procedure / Description	LCD indication
1	Press and hold “Fan” key for 2 seconds to check the filter counter.	
2	Press and hold “Prog” key for 2 seconds to reset the filter counter after replace a new filter. Press “Home” key once to back to the Home page.	
	FILTER icon will be displayed at Home page after <u>500 hours</u> usage.	

Reset ZTS-100 to factory default settings

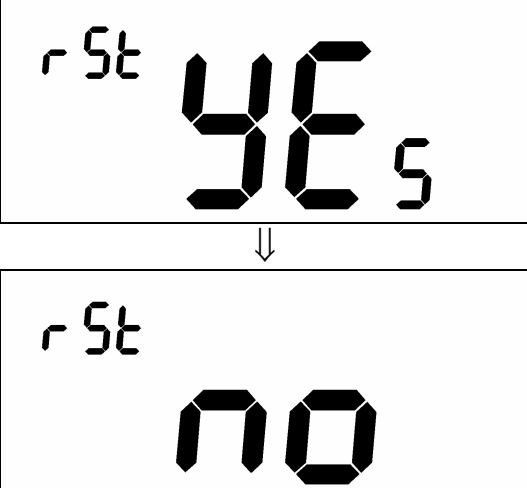
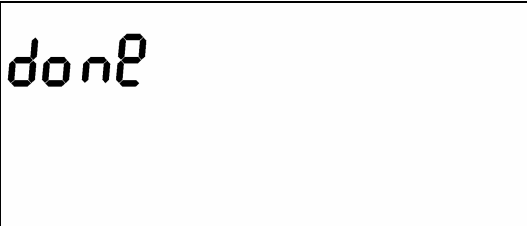
Step	Procedure / Description	LCD indication
1	<p>Press and hold “Fan” + “Mode” keys for 2 seconds to entry the reset mode.</p> <p>Press Up/Down key to toggle Yes/No selection.</p>	 <p>The LCD display shows 'rSt' in the top left corner. The main display area shows '4E5'. A downward arrow points from the center of the display to a second display area where 'rSt' is in the top left and 'no' is in the center.</p>
2	<p>Press “Prog” key once to confirm the action.</p> <p>=> It will perform the reset if select “Yes” . or</p> <p>=> It will back to home page if select “No” .</p> <p>LCD display done after reset to factory default settings.</p> <p>(The following data will be reset to default:</p> <ol style="list-style-type: none"> 1. Clock : 12:00am 2. Day: Mon 3. Temperature scale: F 4. Swing : 2F 5. Diff: 2F 6. Default schedule 7. Operation mode: OFF 8. Default Heat override set point 9. Default Cool override set point 10. Filter counter cleared 11. Delete from network 	 <p>The LCD display shows the word 'done' in a stylized font.</p>

Battery Low indication

Step	Procedure / Description	LCD indication
1	ZTS-100 thermostat will detect the battery level every 30 minutes; <u>Battery low</u> icon will be displayed at Home page if the battery is running out. (User is needed to replace new batteries.)	

Defrost indication

Step	Procedure / Description	LCD indication
1	<u>DEFROST</u> icon will be displayed at Home page if temperature below 41°F/5°C All heaters will be forced On, except in cool mode.	

Out of temperature range indication

Step	Procedure / Description	LCD indication
1	<u>HI</u> icon will be displayed on LCD if temperature excess the measurement ranges 99°F/40°C. All heaters will be forced Off. Cooler will turn on if running cool mode.	
2	<u>LO</u> icon will be displayed on LCD if temperature below the measurement ranges 32°F/0°C. All heaters will be forced On, except in cool mode.	

Advance Recovery indication

Step	Procedure / Description	LCD indication
1	<p>The Advance Recovery feature allows heating and cooling systems to gradually recover from an energy-saving set point temperature to a comfort set point temperature. Advance Recovery calculates the time needed to adjust the temperature to the next program setting for the Morning and Evening schedules. When the thermostat is in Advance Recovery mode, the display will show “RECOVERY”.</p> <p>Advance Recovery is an option that allows the HVAC system to attempt to recover from a setback period and reach a desired comfort temperature set point by the beginning of your programmed comfort period. This option allows the choice whether to use Advance Recovery.</p> <p>(Recovery works in heat or cool mode.</p> <p>Maximum Smart Recovery time is one hour.)</p>	

Short cycle start up protection

To protect the compressor / Heat pump, those outputs forced off until 3minutes count down finished.

Those outputs can be activated according to the room temperature after 3 minutes.

System	Output
Non Heat pump system	Compressor
Heat pump system	1st stage heat and compressor

FREQUENTLY ASKED QUESTIONS

Q Why won't my ZTS-100 work with the Z-Wave devices I purchased from another country?

A Due to different countries regulations Z-Wave products from different regions are set to different frequencies. Before purchasing new devices make sure you have checked to see that the device is compatible in your region.

Q Do I need an electrician to install ZTS-100 in my house?

A It is recommended to install this product by a qualified technician.

Q How do I know which product is compatible to my ZTS-100?

A ZTS-100 should work with any Z-Wave controller or gateway has control capability for "Thermostat" devices. You can check either the specifications in the manual of your ZTS-100 or also check online at www.remotec.com.hk for a full list of products that can be used with your ZTS-100. All Z-Wave products also come with the Z-Wave logo.



Q Can I use 2 or more ZTS-100 in my house? What is the max. units if yes?

A Yes and it is very depend on the capability of gateway / controller. For example, gateway can supports up to 8, 16 or 32 ZTS-100 in a network.

Q Where can I keep up to date with the latest Z-Wave products for my house?

A You can keep up to date by visiting the www.remotec.com.hk website where we will have information and ideas for using Z-Wave technology.

Q What are the operation for Swing and Differential set point?

A Below are the detail explanations.

HEAT mode: thermostat controls the temperature according to the following diagram

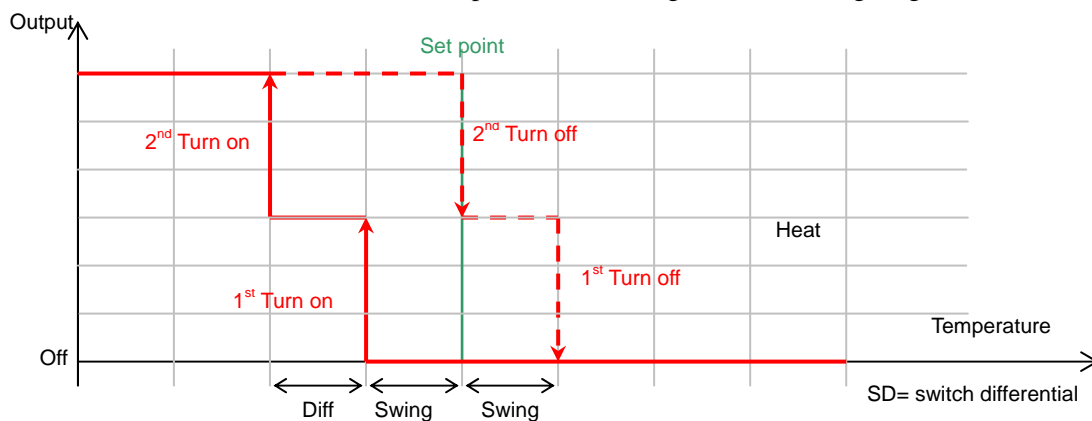

Example for Heating: (Set point = 70 °F, Swing = 1 °F, Differential = 2 °F)

=> 1st stage heater turns on when room temp is 69 °F and off at 71 °F.

=> 2nd stage heater turns on when room temp is 67 °F and off at 70 °F.

COOL Mode: thermostat controls the temperature according to the following diagram

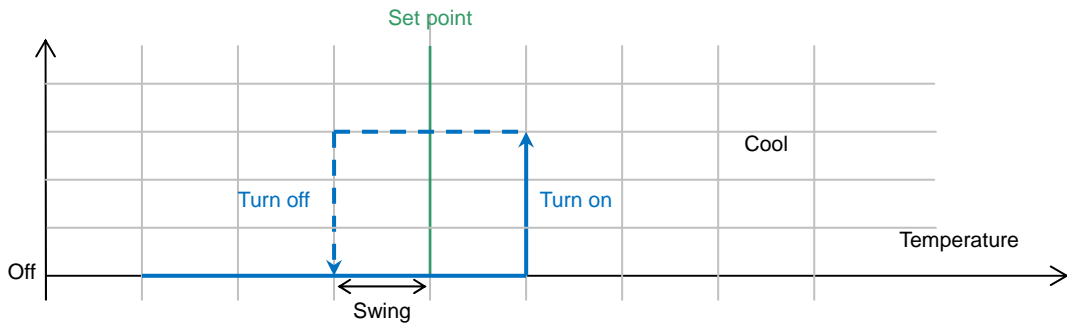

Example for Cooling: (Set point = 80 °F, Swing = 1 °F)
=> Cooler turns on when room temp is 81 °F and off at 79 °F.

AUTO: thermostat controls the temperature according to the following diagram

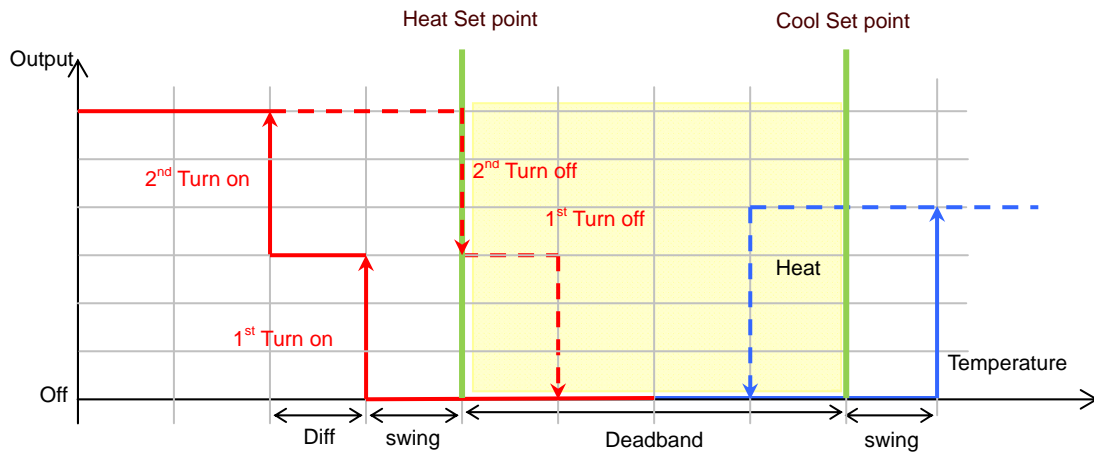

There is a dead band 4°F/2°C between heat set point and cool set point.

Example 1: If user select heat set point is 70F, the minimum cool set point will be limited at "heat set point + 4°F: 74°F

Pervious heat set point is 70°F and cool set point is 74°F

Example 2: If user changes heat set point to 72F, cool set point will be updated to 76°F automatically to maintain the dead band.

TECHNICAL SPECIFICATIONS

Model no.	BW8030US (ZTS-100US) BW8030EU (ZTS-100EU) BW8030AU (ZTS-100AU)
RF frequency	908.4MHz (US) (ZTS-100US) 868.4MHz (EU) (ZTS-100EU) 921.4MHz (AU) (ZTS-100AU)
RF operating distance	up to 100ft outdoor line of sight, in unobstructed environment
LCD	TN type with white backlight VA=66.5mmx28.5mm
Powered by	Dry battery AA x 4pcs or 24 VAC 50/60Hz
Relay contact	Voltage: 24 VAC 50/60 Hz Current: 1A Max. (inductive)
Temperature measurable range	32 – 99 °F / 0 – 40 °C
Temperature display resolution	0.5°F / 0.1 °C
Temperature Setting range	41-99 °F / 5-37 °C
Temperature	Operating: 32 – 122 °F / 0 – 50 °C Storage: 23 – 140 °F / -5 – 60 °C
Dimension (L x H x T)	145mm x 100mm x 25mm
Weight	170g (Batteries excluded)

Z-Wave device type		
Basic Device Class: Routing_Slave (Enhanced_Lib)		
Generic Device Class: Thermostat		
Specific Device Class: Thermostat general v2		
Z-Wave Command Class	Controlled	Supported
COMMAND_CLASS_THERMOSTAT_FAN_MODE	NO	YES
COMMAND_CLASS_THERMOSTAT_FAN_STATE	NO	YES
COMMAND_CLASS_THERMOSTAT_MODE	NO	YES
COMMAND_CLASS_THERMOSTAT_SETPOINT	NO	YES
COMMAND_CLASS_THERMOSTAT_OPERATING_STATE	NO	YES
COMMAND_CLASS_THERMOSTAT_SETBACK	NO	YES
COMMAND_CLASS_CLIMATE_CONTROL_SCHEDULE	NO	YES
COMMAND_CLASS_SENSOR_MULTILEVEL	NO	YES
COMMAND_CLASS_CLOCK	NO	YES
COMMAND_CLASS_BATTERY	NO	YES
COMMAND_CLASS_BASIC	NO	YES
COMMAND_CLASS_VERSION	NO	YES
COMMAND_CLASS_MANUFACTURER_SPECIFIC	NO	YES

CHECKING THE ACCESSORIES

After opening the cover of the packing box, check that the following accessories are included.

- ZTS-100: Z-Thermostat
- Screw x 4pcs
- User Manual (download from our website)

FCC NOTICE

This device complies with Part 15 of the FCC rules. Operation is subject to the following two conditions:

- (1) this device may not cause harmful interference, and
- (2) this device must accept any interference received, including interference that may cause undesired operation.

WARNINGS

Changes or modifications not expressly approved by the party responsible for compliance could void the user's authority to operate the equipment.

- **RISK OF FIRE**
- **RISK OF ELECTRICAL SHOCK**
- **RISK OF BURNS**

Do not dispose of electrical appliances as unsorted municipal waste, use separate collection facilities. Contact your local government for information regarding the collection systems available.

CAUTION

- **RISK OF EXPLOSION IF BATTERY IS REPLACED BY AN INCORRECT TYPE.**
- **DISPOSE OF USED BATTERIES ACCORDING TO THE INSTRUCTIONS.**

www.remotec.com.hk